

Test fit parts before gluing! Wash parts with warm soapy water before starting. Use Cyano-Acrylate (superglue) to glue parts. Use hot water if you need to fix any warps. Lightly sand and prime resin parts before painting. Have fun! Check out WWW.Aircraftresourcecenter.com for tips on building models. Learn, teach and share pictures of your models at ARCs Discussion forum.

Note the fuselage mounted BD3-60-23 pylons are different left and right. They are contoured to fit the fuselage and will only fit one side each.

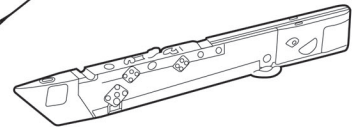
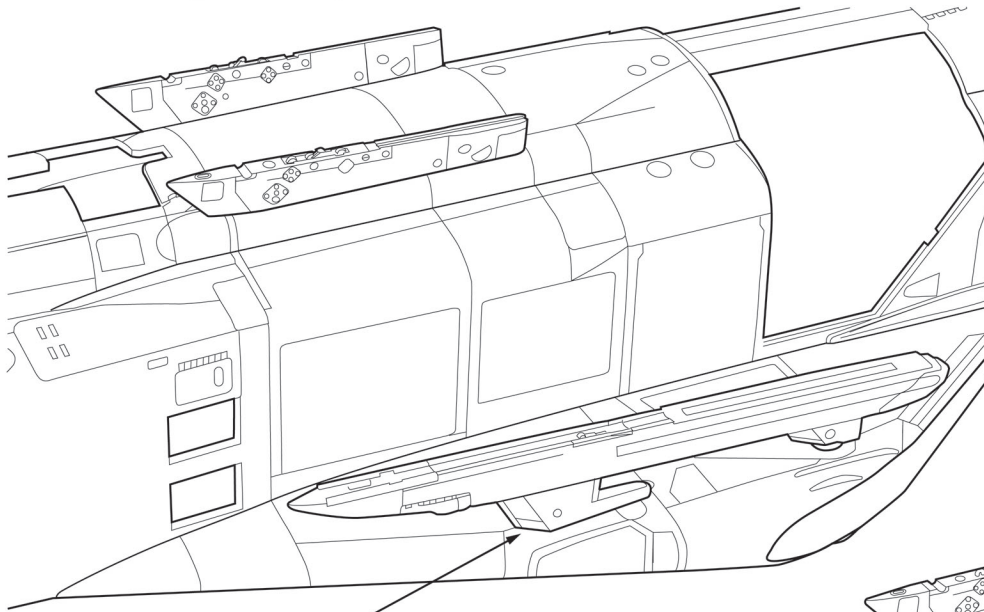

The APU-23 is also different left and right. Note the angle on the stub pylon is similar to the angle of the wing edge.

The wing mounted BD3-60s are the same left and right. (1 out of 3 ain't bad...)

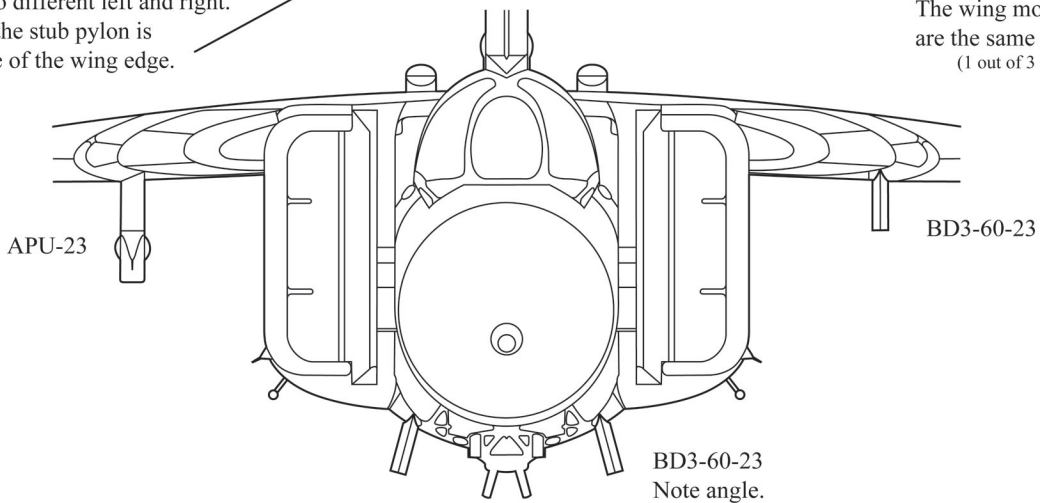

BD3-60-23 Hardware options

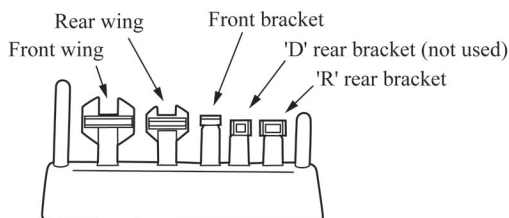

Note that wings have a small dot on the top forward surface.

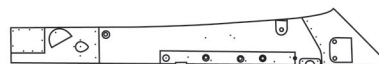

No brackets

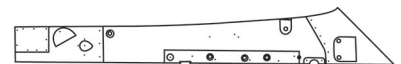

Rear bracket only

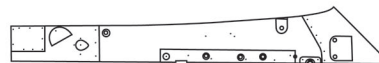

Front bracket only

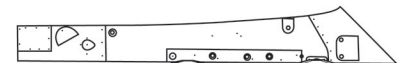

Front and rear 'wings'

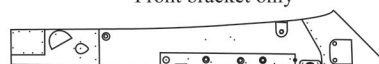

Front and rear brackets

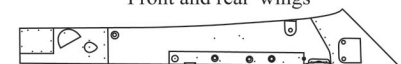

Front wing and rear bracket